



WARNING:

BEFORE USING THIS FIREARM, READ AND FOLLOW THESE INSTRUCTIONS

If there is anything you do not understand, get help from someone qualified in the safe handling of firearms.



**SAFETY
AND
INSTRUCTION
MANUAL**

DETECTIVE SPECIAL®

DIAMONDBACK®

POLICE POSITIVE®

COMMANDO® SPECIAL

AGENT®

COBRA®

VIPER™

Copyright© 2002 Colt's Manufacturing Company, Inc. All Rights Reserved.
This instruction manual should always accompany this pistol.
When you lend, give or sell this firearm, be sure this manual goes with it.

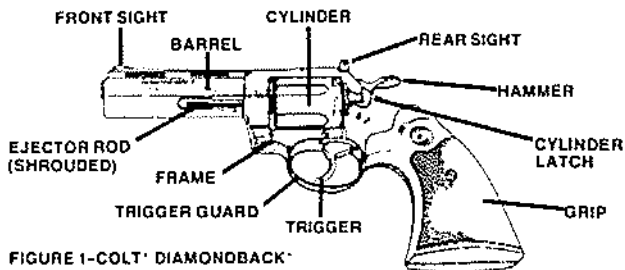

FIGURE 1-COLT' DIAMONDBACK'

CAUTION: ALWAYS KEEP AND CARRY YOUR REVOLVER EMPTY, WITH THE HAMMER FORWARD EXCEPT WHEN YOU INTEND TO SHOOT, so that your revolver cannot be fired when you do not mean to fire it.

CAUTION: USE ONLY CLEAN, DRY, ORIGINAL HIGH QUALITY COMMERCIALLY MANUFACTURED AMMUNITION IN GOOD CONDITION which is appropriate to the caliber of your revolver—see table opposite.

CAUTION: COLT DOES NOT RECOMMEND THE USE OF +P+ 38 SPECIAL CARTRIDGES OR ANY VARIATION OF THAT AMMUNITION IN D FRAME REVOLVERS, (i.e. those listed in this manual). The use of +P+ ammunition would significantly reduce the service life of D frame revolvers, will void any of Colt's obligations for service and could eventually render the revolvers unsafe or non-functional.

This manual describes revolvers in the Colt Model D line, whether or not they are in current production. It gives you information to help you use yours safely. That information includes the following table which tells you the type of ammunition to use in your revolver.

D FRAME REVOLVER TYPE	SUITABLE AMMUNITION	
	38 Special	+ P 38 Special
Agent 38 Special	Yes	Limited use ★ (Aluminum frame)
Cobra 38 Special	Yes	Limited use ★ (Aluminum frame)
Commando Special 38 Special	Yes	Yes ★ (Steel frame)
Detective Special 38 Special	Yes	Yes ★ (Steel frame)
Diamondback 38 Special	Yes	Yes ★ (Steel frame)
Police Positive 38 Special	Yes	Yes ★ (Steel frame)
Viper 38 Special	Yes	Limited use ★ (Aluminum frame)
Diamondback 22 Long Rifle (LR)	Use 22 Long Rifle (LR) ammunition only. Do not use 22 Magnum.	

★ Extensive use of + P 38 Special ammunition will accelerate wear in your revolver. For continued satisfactory performance, have it checked at a Colt Authorized Repair Service Station periodically. Intervals should be every 1000 rounds in aluminum frames and 2000 to 3000 rounds in steel frames.

NOTE: If you want to use + P+ 38 ammunition, buy a Colt revolver chambered for 357 Magnum cartridges. The dealer will be pleased to show you the Colt revolvers which are suitable and available.

SAFETY DEPENDS ON YOU

READ AND UNDERSTAND ALL THE FOLLOWING PRECAUTIONS BEFORE REMOVING THIS FIREARM FROM ITS PACKAGE.

This Colt product is classified by the Alcohol, Tobacco and Firearms Division of the Internal Revenue Service, U.S. Treasury Department, as a firearm or dangerous weapon; it is, therefore, potentially lethal!

WARNING: IF THIS FIREARM IS CARELESSLY OR IMPROPERLY HANDLED, UNINTENTIONAL DISCHARGE COULD RESULT AND COULD CAUSE INJURY, DEATH, OR DAMAGE TO PROPERTY.

CAUTION: CAREFULLY READ THIS INSTRUCTION MANUAL WHICH GIVES BASIC ADVICE ON THE PROPER HANDLING AND FUNCTIONING OF THIS COLT FIREARM PRIOR TO LOADING AND FIRING. However, your safety and the safety of others (including your family) depends on your mature compliance with that advice, and your adoption, development and constant employment of safe practices.

If unfamiliar with firearms, seek further advice through safe handling courses run by your local gun clubs, NRA approved instructor, or similar qualified organizations.

NOTICE

Colt shall not be responsible for injury, death, or damage to property resulting from either intentional or accidental discharge of this firearm, or from its function when used for purposes or subjected to treatment for which it was not designed. Colt will not honor claims involving this firearm which result from careless or improper handling, unauthorized adjustment or parts replacement, corrosion, neglect, or the use of wrong caliber ammunition, or the use of ammunition other than original high quality commercially manufactured ammunition in good condition, or any combination thereof. Colt will not honor claims involving this firearm for any reason or cause when such claims are made by the second or subsequent owner.

IMPORTANT

Before it left the factory this firearm was tested, carefully inspected, and packaged. Colt cannot control product handling after it leaves the factory; therefore, please examine this firearm carefully at the time of purchase to insure that it is unloaded and undamaged. The dealer will be pleased to assist you in making this examination and endeavor to answer your further questions.

This instruction manual should always accompany this firearm. When you lend, give or sell this firearm, be sure this manual goes with it.

LIST OF SECTIONS

SECTION	TITLE	PAGE	SECTION	TITLE	PAGE
1	PRECAUTIONS	2		Unloading	24
2	Main Features	5		To Unload	24
3	Safety Instructions:	7		Firing and Sight Adjustment	26
	Cautions	7		To Fire	28
	Safety Features:	15	5	Maintenance:	32
	Trigger Guard	15		When to Clean	32
	Safety	15		How to Clean	33
	Hammer Heel			Storage	35
	and Rebound Lever	16		Servicing and	
	Hand	17		Repair	36
4	Function:	18	6	Parts Illustration	
	Ammunition Selection	19		and List	39
	Loading	20	7	The Customized	
	To Load	20		Gun	42
	Carrying Modes	23			

The Colt Model D line consists mostly of 38 Special caliber revolvers which vary in weight, grip and barrel length. The Diamondback (illustrated throughout this manual) was produced in both 38 Special and 22 LR calibers. Unlike other Model D's, it features a ribbed barrel and adjustable rear sight. Otherwise, these revolvers are all basically similar, each one featuring a standard ejector rod, an automatic safety, and above all a smooth crisp dual single and double action. Stocks may be wood or wrap around rubber.

Different types of Model D revolvers are shown in the following table, and this safety and instruction manual applies to all of them. It also applies to commemorative issues of the same type.

NOTE: These features may change, for example, with the introduction of new models.

Pistol Type	Barrel Length	Finishes	Sights	Special Features
Agent 38 Special (with or without hammer shroud)	2"	Non Glare	Fixed square notch rear. Ramp style front.	Aluminum alloy frame
Cobra 38 Special	2" or 3"	Colt Blue or Nickel	As above.	As above.
Commando Special 38 Special	2"	Non Glare	As above.	Steel frame.
Detective Special 38 Special	2"	Colt Blue or Nickel	As above.	Steel frame.
Diamondback 38 Special	4" 6"	Colt Blue	Fully adjustable rear. Ramp style front.	Steel frame and ventilated barrel rib.
Diamondback 22 Long Rifle	4" 6"	Colt Blue Colt Blue or Nickel	As above.	As above.
Police Positive 38 Special	4"	Colt Blue or Nickel	Fixed square notch rear. Ramp style front.	Steel frame.
Viper 38 Special	4"	Colt Blue or Nickel	As above.	Aluminum alloy frame.

We want you to enjoy shooting your Colt revolver, but we want you to enjoy it safely. You may be an experienced safe shooter already familiar with the procedures in this instruction manual, or you may never have handled a gun before. Either way we urge you to **READ THIS ENTIRE INSTRUCTION MANUAL CAREFULLY. YOU MUST FOLLOW THE SAFETY INSTRUCTIONS FOR YOUR SAFETY AND THE SAFETY OF OTHERS.**

WARNING: When you squeeze the trigger, you must expect the gun to fire, and you must take full responsibility for firing it. Your care can avoid accidental discharge, and you will thereby avoid accidental injury and death.

CAUTIONS:**GENERAL HANDLING CAUTIONS**

- 1. ALWAYS HANDLE YOUR REVOLVER AS IF IT WERE LOADED** so that you never fire it accidentally when you think it is unloaded.
- 2. NEVER POINT YOUR REVOLVER AT ANYTHING YOU DO NOT INTEND TO SHOOT** so that if it fires accidentally, injury, death, or damage to property will be prevented.

SAFETY DEPENDS ON YOU

3. NEVER TAKE ANYONE'S WORD THAT A GUN IS UNLOADED: check for yourself with fingers off the trigger and gun pointed in a safe direction, so that you never fire the gun accidentally when you think it is unloaded.

4. ALWAYS MAKE SURE YOUR REVOLVER IS NOT LOADED AND SWING THE CYLINDER OPEN BEFORE LAYING IT DOWN, OR HANDING IT TO ANOTHER PERSON, so that it cannot be fired when it is unsafe to do so.

5. ALWAYS KEEP AND CARRY YOUR REVOLVER EMPTY, WITH THE HAMMER FORWARD except when you intend to shoot, so that your revolver cannot be fired when you do not mean to fire it.

6. ALWAYS BE AWARE OF POSSIBLE RISK FROM DROPPING YOUR REVOLVER. Some parts of the mechanism could be damaged. You may not see the damage but if it is severe, the revolver may discharge and cause injury, death, or damage to property. If your revolver has been dropped, have it examined by a competent gunsmith before using it again.

7. NEVER LEAVE REVOLVER COCKED READY TO FIRE as this condition is extremely dangerous, and revolver could easily be accidentally discharged, causing injury, death, or damage to property.

8. NEVER LEAVE A LOADED REVOLVER UNATTENDED. Someone, especially a child, may fire it and cause injury, death, or damage to property.

9. ALWAYS INSTRUCT CHILDREN TO RESPECT FIREARMS. If you teach your children to shoot, teach them or get them trained by a qualified instructor to treat and use the revolver properly, and always supervise them closely. Always stress safety so that your children will not fire the revolver when it is unsafe to do so.

RANGE CAUTIONS

10. ALWAYS BE SURE YOUR BACKSTOP IS ADEQUATE to stop and contain bullets before beginning target practice so that you do not hit anything outside the range shooting area. **THINK!** *What will you HIT if you MISS the target?*

11. ALWAYS PUT A KNOWLEDGEABLE AND RESPONSIBLE PERSON IN CHARGE TO MAINTAIN SAFETY CONTROL WHEN A GROUP IS FIRING ON A RANGE. Obey his commands so that discipline is maintained to reduce the likelihood of accidents.

12. ALWAYS CARRY YOUR REVOLVER EMPTY WITH THE CYLINDER OPEN WHILE ON A RANGE until preparing to fire, keep it pointing

towards the backstop when loading, firing and unloading, to eliminate the risk of injury, death, or damage to property.

LOADING/UNLOADING CAUTIONS

13. ALWAYS EXERCISE EXTREME CARE TO KEEP MUZZLE POINTING IN A SAFE DIRECTION, WELL CLEAR OF YOUR BODY, particularly when loading and unloading revolvers.

14. ALWAYS BE SURE BARREL BORE AND CYLINDER CHAMBERS ARE CLEAN AND CLEAR OF OBSTRUCTIONS. Clean a fouled revolver immediately so that it will function correctly and safely.

15. ALWAYS USE ONLY CLEAN, DRY, ORIGINAL HIGH QUALITY COMMERCIALY MANUFACTURED AMMUNITION IN GOOD CONDITION WHICH IS APPROPRIATE TO THE CALIBER OF YOUR REVOLVER. (See page 1.) Gun and ammunition manufacturers design their products within exacting engineering safety limits. Handloads and remanufactured ammunition are sometimes outside those limits and can be so unsafe as to blow up the cylinder and frame and cause injury, death, or damage to property.

16. ALWAYS LEAVE EMPTY CHAMBER UNDER THE HAMMER to achieve maximum safety with a loaded revolver.

SHOOTING CAUTIONS

17. NEVER DRINK ALCOHOLIC BEVERAGES OR TAKE DRUGS BEFORE OR DURING SHOOTING, because your vision, coordination and judgment could be seriously impaired making your gun handling unsafe.

18. ALWAYS SEEK A DOCTOR'S ADVICE IF YOU ARE TAKING MEDICATION, to be sure you are fit to shoot and handle your revolver safely.

19. ALWAYS WEAR AND ENCOURAGE OTHERS TO WEAR EAR PROTECTION WHEN SHOOTING, especially on a range. Without ear protection, the noise of even one shot from your revolver, and other guns close to you, could leave a "ringing" in the ears for some time after firing, while the cumulative long term effect could be permanent hearing loss.

20. ALWAYS WEAR AND ENCOURAGE OTHERS TO WEAR PROTECTIVE SHOOTING GLASSES. Flying particles could damage eyes and cause blindness; but protective shooting glasses should prevent such injury.

21. ALWAYS HOLD REVOLVER BY THE GRIP AND KEEP BOTH HANDS WELL CLEAR OF, AND BEHIND THE CYLINDER. Never hold it near the cylinder as very hot gas and lead particles may be sprayed out around the cylinder . . . these would injure your hands.

22. NEVER SQUEEZE THE TRIGGER OR PUT YOUR FINGER IN THE TRIGGER GUARD UNTIL YOU ARE AIMING AT A TARGET AND READY TO SHOOT. This will prevent you from firing the revolver when it is pointing in an unsafe direction.

23. ALWAYS BE ABSOLUTELY SURE OF YOUR TARGET AND THE AREA BEHIND IT BEFORE YOU SQUEEZE THE TRIGGER. A bullet could travel through or past your target up to 1½ miles . . . if in doubt, don't shoot. **THINK! *What will you HIT if you MISS the target?***

24. NEVER SHOOT AT A HARD SURFACE SUCH AS ROCK, OR A LIQUID SURFACE SUCH AS WATER. A bullet may ricochet and travel in any direction to strike you, or an object you cannot see, causing injury, death, or damage to property.

25. NEVER DISCHARGE A FIREARM NEAR FLAMMABLE MATERIAL. Flame and sparks erupt from the firearm when discharged. They could start a fire or cause flammable liquids and gasses to explode.

26. NEVER FIRE YOUR FIREARM NEAR AN ANIMAL unless it is trained to accept the noise; an animal's startled reaction could injure it or cause an accident.

27. NEVER INDULGE IN "HORSEPLAY" WHILE HOLDING YOUR REVOLVER as it may be accidentally discharged.

28. NEVER WALK, CLIMB OR FOLLOW A COMPANION WITH YOUR REVOLVER COCKED READY TO FIRE, out of its holster, or with the hammer in any position other than forward on an empty chamber, to eliminate risk of accidental discharge. When hunting, hold your revolver so that you can always control the direction of the muzzle.

MALFUNCTION CAUTIONS

29. FAILURE TO FIRE: ALWAYS HOLD REVOLVER, KEEPING IT POINTED TOWARD THE TARGET OR A SAFE OPEN AREA AND WAIT 30 SECONDS when revolver fails to fire. If a hangfire (slow ignition) has occurred, round will fire within 30 seconds. If round does not fire, open cylinder, eject round and examine primer; if firing pin indent on primer is light, off center, or non-existent, have revolver examined by a competent gunsmith before firing again. If firing pin indent on primer appears normal (in comparison with similar previously fired

rounds) assume faulty ammunition; segregate misfired round from other live ammunition and empty cases, reload and carry on firing.

Note: Dispose of misfired rounds in accordance with ammunition manufacturer's instructions.

30. NEVER USE YOUR REVOLVER IF IT FAILS TO FUNCTION PROPERLY. AND NEVER FORCE A JAMMED ACTION, as a round may explode causing serious injury, possible death, or severe damage to your revolver.

CLEANING AND STORAGE CAUTIONS

31. ALWAYS MAKE SURE YOUR REVOLVER IS NOT LOADED BEFORE CLEANING, STORING, TRAVELING, LAYING IT DOWN, OR HANDING IT TO ANOTHER PERSON, so that it cannot be fired when it is unsafe to do so.

32. ALWAYS KEEP AND STORE YOUR REVOLVER AND AMMUNITION IN SEPARATE LOCKED RECEPTACLES OUT OF REACH AND SIGHT OF CHILDREN AND UNTRAINED PEOPLE, to minimize the risk of revolver and ammunition being easily available for loading and firing.

GUN ABUSE CAUTION

33. NEVER ABUSE YOUR REVOLVER by using it for any purpose other than shooting.

NOTE: Please note that we have chosen to use the word "SQUEEZE" in this instruction manual instead of "PULL" or "PRESS" when trigger movement is described; this is simply to remind you of the need for a gentle squeezing action to achieve accuracy.

SAFETY FEATURES

Trigger Guard

The Trigger Guard is a loop around the trigger to protect it from being damaged, bumped or snagged and pulled. It also helps remind you that putting your finger on the trigger should be intentional.

Safety

The safety introduces a positive barrier in front of the hammer. This will prevent the firing pin in the hammer from striking the primer in the cartridge until the trigger is squeezed and held back. In this way, if the hammer is being cocked and it slips from your thumb, or if the revolver is

dropped on the hammer spur, the revolver will not fire provided the trigger is not in the firing position.

To allow the revolver to fire, the safety is withdrawn when the hammer is cocked and will remain withdrawn if the trigger is squeezed and held in the firing position. However, if the trigger is released when the hammer is not fully cocked, the safety will return to prevent the hammer from falling fully forward so that the firing pin cannot strike the primer to fire the revolver.

Another function of the safety is to lock the cylinder latch when the hammer is cocked; in this way the cylinder cannot be moved out of or into the revolver frame. This insures that the hammer is forward while loading and unloading to minimize the risk of accidental discharge.

Hammer Heel & Rebound Lever

After the hammer falls it remains fully forward until the trigger is released. When the trigger is released, normal action of the rebound lever on the hammer heel withdraws and holds the hammer to permit the safety to move into position in front of it.

IMPORTANT: Do NOT flick the hammer unnecessarily, as the hammer heel and rebound lever can be damaged by drawing the hammer partially back and releasing it before it is fully cocked.

Hand

The hand's primary function is to rotate the cylinder. It serves also as a safety device to prevent the cylinder from being moved out of or into the revolver frame when the hammer is cocked, thus minimizing the risk of accidental discharge when the revolver is being loaded or unloaded.

IMPORTANT: These safety devices are designed and installed in this revolver to prevent accidental discharge. Of course, this Colt revolver is designed primarily to discharge bullets, and it will do this efficiently when it is loaded and you squeeze the trigger. *Always expect the gun to fire when you squeeze the trigger.*

This revolver can be fired by single action (cocking hammer by thumb and squeezing the trigger) or double action (squeezing the trigger to cock the hammer and fire the revolver. Either way, the functioning sequence is similar.

When the hammer starts to move rearward, the bolt unlocks the cylinder, the hand rotates the cylinder clockwise and the safety is lowered away from the hammer. When the hammer is about half way to the cocked position, the spring loaded bolt is released to contact the cylinder between the fired and unfired chambers. The cylinder continues to rotate until the bolt drops into the next bolt notch to assure proper alignment of the chamber to the barrel and firing pin.

In single action, when the hammer is cocked it will remain cocked until the trigger is squeezed. In double action, pulling the trigger through to the rearward firing position both cocks and releases the hammer allowing it to move forward and fire the revolver.

When the firing pin strikes the primer in the base of the cartridge, energy imparted to the primer ignites it, this in turn ignites the main powder charge. Extremely high gas pressure generated by the burning powder

forces the bullet out of the mouth of the cartridge case, forward out of the cylinder, across the barrel/cylinder gap and into the throat of the barrel. In the barrel, rifling imparts stabilizing spin to the bullet so that it will follow a more accurate path to the target. Upon releasing the trigger, the rebound lever rotates the hammer back slightly allowing the firing pin to withdraw and the safety to move up in front of the hammer.

AMMUNITION SELECTION

Colt firearms are designed to function with a variety of brands and types of factory-manufactured ammunition in the appropriate caliber; but not all ammunition produces the same result. Colt recommends that after you read and understand this manual, you go to the range and fire different ammunition which is appropriate to the caliber of your firearm as recommended on page 1. Once you find the ammunition which functions best, keep using it when you most need it, especially when cutting-edge reliability and accuracy are vital to you. **Every time before you load your revolver, examine the ammunition, particularly on and around the primer. Look for dents, scratches and other signs of damage. Do not load damaged ammunition.**

LOADING

CAUTION: TO MINIMIZE RISK OF UNINTENTIONAL DISCHARGE, LOAD LIVE AMMUNITION INTO REVOLVER ONLY WHEN YOU INTEND TO SHOOT, AND THEN KEEP AN EMPTY CHAMBER UNDER THE HAMMER.

CAUTION: ALWAYS EXERCISE EXTREME CARE TO KEEP MUZZLE POINTING IN A SAFE DIRECTION, WELL CLEAR OF YOUR BODY, particularly when loading and unloading revolvers.

To Load:

- 1. CAUTION:** READ SAFETY INSTRUCTIONS (Section 3)—KEEP REVOLVER POINTING IN SAFE DIRECTION AND DO NOT TOUCH THE TRIGGER.
2. Open revolver by pulling cylinder latch to the rear and pushing cylinder out to the left (See Figure 2). Check each of six chambers to ensure they are clean and free from accumulated oil. (Clean if necessary).

3. Use only ammunition recommended on page 1 of this instruction manual as suitable for your revolver and make sure it is in good condition.

Insert a round of ammunition into a chamber.

4. Press round home until it is fully seated.

5. Repeat steps 3 and 4 until revolver is loaded with 5 rounds for maximum carrying safety; 6 rounds if firepower is more important.

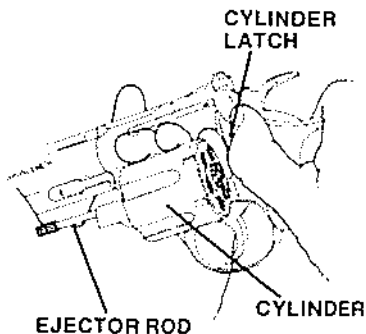

FIGURE 2-OPENING REVOLVER

CAUTION: LEAVE ONE CHAMBER EMPTY AND INSURE IT REMAINS IN FRONT OF HAMMER AND IN LINE WITH BARREL, for safest method of carrying a loaded revolver.

6. KEEP REVOLVER POINTING IN SAFE DIRECTION. Ensure hammer is not cocked. Push cylinder into frame until the cylinder latch springs forward to lock the cylinder. When only 5 rounds are loaded make sure by looking at the back of the cylinder that the empty chamber is in the firing

position. (In line with the barrel and hammer.) If the empty chamber is not correctly positioned, open the revolver and repeat this step until the empty chamber remains in the firing position. **THE REVOLVER IS NOW LOADED AND READY TO FIRE BY JUST SQUEEZING THE TRIGGER.**

IMPORTANT: Do not attempt to close cylinder with hammer cocked. Do not swing or slam cylinder forcibly into place in the frame. If you do, you could damage the mechanism.

IMPORTANT: It is sometimes possible that the bolt will not correctly engage cylinder to lock it. Check for correct locking by attempting to rotate cylinder gently clockwise by hand. If it is already locked, the cylinder will not move. If it was unlocked, you should hear the bolt "click" into engagement with the cylinder to lock it. Then look at the back of the cylinder to ensure that the empty chamber remains in the firing position.

CARRYING MODES

NOTE: This revolver may be carried in any one of the following three modes according to your needs:

- Mode 1: — Cylinder empty, hammer forward.
- Revolver cannot be discharged.
 - Use Mode 1 for storage, transporting, cleaning, repair, demonstrating and dry practice.
 - Also use Mode 1 *with cylinder open* when laying revolver down, carrying it on a range, and when handing it to, or receiving it from, another person.
- Mode 2: — Cylinder loaded with 5 rounds, empty chamber under hammer, hammer forward.
- Revolver cannot be discharged unless trigger is pulled.
 - Use Mode 2 when **CARRYING THE REVOLVER READY FOR USE.**
- Mode 3: — Cylinder loaded with 6 rounds, hammer forward.
- Revolver can be fired when trigger is squeezed.
 - Use Mode 3 when you must have **MAXIMUM FIREPOWER IMMEDIATELY AVAILABLE.**

WARNING: When you squeeze the trigger, you must expect the gun to fire, and you must take full responsibility for firing it. Your care can avoid accidental discharge, and you will thereby avoid accidental injury and death.

UNLOADING

CAUTION: ALWAYS UNLOAD YOUR REVOLVER IMMEDIATELY AFTER USE AND BEFORE CLEANING AND STORAGE to minimize the risk of accidental discharge.

To Unload:

1. CAUTION: READ SAFETY INSTRUCTIONS (Section 3)—KEEP REVOLVER POINTING IN SAFE DIRECTION AND DO NOT TOUCH THE TRIGGER.

2. Open revolver by pulling cylinder latch to the rear and pushing the cylinder out to the left of revolver (See Figure 2).

3. Push ejector rod backwards forcing out all live rounds or empty cases (See Figure 3). When they are clear of the chambers, remove from revolver. Allow ejector rod to return forward under its spring action.

IF YOU ARE UNLOADING LIVE AMMUNITION, BE CAREFUL NOT TO LET IT FALL ONTO A HARD OBJECT OR SURFACE, AS IT MAY FIRE.

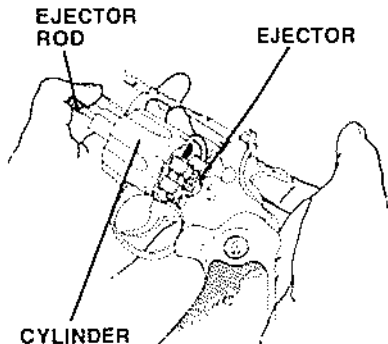

FIGURE 3-EJECTION

4. Ensure hammer is not cocked. Push cylinder into the frame until cylinder latch springs forward to lock cylinder.
5. Collect undamaged live ammunition for safe storage and future use. Collect spent cartridge cases for disposal. **Segregate misfired and damaged live ammunition for disposal according to ammunition manufacturer's instructions.**

FIRING AND SIGHT ADJUSTMENT

Before firing your Colt pistol, practice your stance, aim, rhythm and breathing for steady aim with your pistol UNLOADED. You can also dry-fire your revolver to get the feel of the trigger action so that you can develop some shooting skills without ammunition. You should then practice firing on a range before going hunting or using your revolver for any other type of shooting.

The Diamondback is fitted with the Colt Accro® rear sight. (See Figure 4).

To adjust the Accro sight, turn windage screw clockwise and sight moves to left; counterclockwise and it moves to right. Turn elevation screw clockwise to lower sight; counterclockwise to raise it. Point of bullet impact will move in the same direction. It is recommended that adjustments for other than windage and elevation be made only by experienced persons.

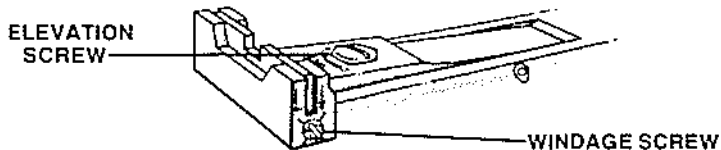

FIGURE 4--COLT ACCRO REAR SIGHT

CAUTIONS:

- 1. ALWAYS WEAR AND ENCOURAGE OTHERS TO WEAR EAR PROTECTION WHEN SHOOTING,** especially on a range. Without ear protection, the noise from your revolver, and other guns close to you could leave a "ringing" in the ears for some time after firing, while the cumulative long term effect could be permanent hearing loss.
- 2. ALWAYS WEAR AND ENCOURAGE OTHERS TO WEAR PROTECTIVE SHOOTING GLASSES.** Flying particles could damage eyes and cause blindness; but protective shooting glasses should prevent such injury.

To Fire:

1. CAUTION: READ SAFETY INSTRUCTIONS (Section 3)—KEEP REVOLVER POINTING IN SAFE DIRECTION AND DO NOT TOUCH THE TRIGGER.

2. Load revolver as previously described. It can now be fired in either single action (see paragraph 3S) or double action (see paragraph 3D).

3. (S) 1. *To fire single action*, grasp revolver by its grip, keeping fingers away from trigger and draw hammer fully back (about an inch) to the cocked position where it will be held to the rear (See Figure 5). Remove thumb from hammer spur.

2. Take aim by aligning target with front and rear sights (See Figure 6). Now focus on the front sight.

3. Keeping steady aim, place index finger on trigger and squeeze gently until hammer falls. Don't jerk the trigger as you will disturb your aim and spoil your accuracy.

4. To fire second and subsequent rounds, remove finger from trigger, cock hammer, squeeze trigger and repeat until you have completed firing.

5. When you have completed firing, remove finger from trigger.

3. (D) *To fire double action.* Grasp revolver by its grip and keep fingers away from hammer. Aim by aligning target with front and rear sight and squeeze trigger until hammer is cocked and released to fire the revolver. To fire second and subsequent rounds, release trigger and squeeze it again. Repeat until you have completed firing, then remove finger from trigger.

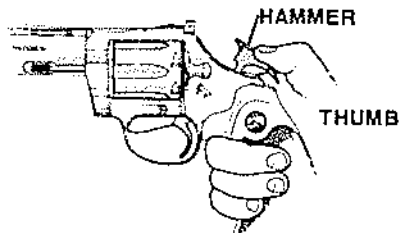

FIGURE 5-
COCKING-SINGLE ACTION

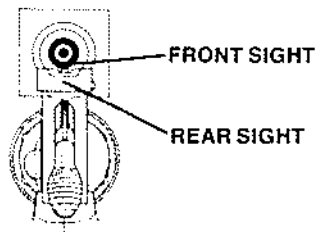

FIGURE 6-AIMING

CAUTION: FAILURE TO FIRE: ALWAYS HOLD REVOLVER, KEEPING IT POINTED TOWARDS THE TARGET OR A SAFE OPEN AREA AND WAIT 30 SECONDS WHEN REVOLVER FAILS TO FIRE. If a hangfire (slow ignition) has occurred, round will fire within 30 seconds. If round does not fire, eject round and examine primer in base of misfired round. If firing pin indent on primer is light, misaligned or non-existent, have revolver examined by a competent gunsmith. If firing pin indent on primer appears normal (in comparison with similar previously fired rounds) assume faulty ammunition; segregate misfired round from other live ammunition and empty cases, reload and carry on firing.

NOTE: Dispose of misfired rounds in accordance with the ammunition manufacturer's instructions.

4. **KEEP REVOLVER POINTING IN SAFE DIRECTION.** Unload revolver as previously described.

CAUTION: NEVER LEAVE REVOLVER COCKED READY TO FIRE as the fire condition is extremely dangerous, and revolver could easily be accidentally discharged causing injury, death, or damage to property.

IMPORTANT: LOWERING A COCKED HAMMER ON A LIVE ROUND:

If you cock your revolver but do not fire it, return hammer to safety position as follows: Place thumb firmly on hammer spur. Squeeze trigger only long enough to allow hammer to move forward and clear cocked notch. Release trigger completely before lowering the hammer gently all the way forward. At this point, a live round is in the firing chamber. If you fire again it will be missed until the cylinder makes a complete revolution. Also, the live round in the firing chamber makes the revolver less safe to carry.

To make sure the live round is not missed and to make the loaded revolver safe to carry, open the cylinder and rotate it *one chamber* counterclockwise. Close the cylinder. Now, either the empty chamber or the spent case of a previously fired round will be in the firing chamber. This makes the loaded revolver safe to carry and the live round will again be ready to move into the firing position when the revolver is cocked.

If you lose the opportunity to fire, unload your revolver as previously described. It is important to lower the hammer gently forward to prevent damage to the hammer heel and rebound lever and to minimize risk of accidental discharge.

A Colt revolver, like any other precision mechanism, will perform better, last longer and remain safer when it is properly maintained. Follow the instructions in this section to keep your revolver in peak condition.

CAUTION: ENSURE THAT THE REVOLVER IS NOT LOADED BEFORE CLEANING, SO THAT IT WILL NOT FIRE. Look in **EVERY** chamber and make sure **ALL** are empty.

IMPORTANT: Do not strip your revolver. If additional maintenance is required see "Servicing and Repair" later in this instruction manual.

WHEN TO CLEAN

You should clean your revolver as soon after firing as possible so that the job will be easier and there will be less opportunity for corrosion to start. When your revolver has not been fired, clean it periodically; we suggest once or twice a year in a temperate climate, or as often as once a month in a tropical climate. If you carry a loaded revolver, **UNLOAD** it and clean it at least once a month.

HOW TO CLEAN

The following cleaning procedure may be used both periodically and after firing; however, those items marked "*" are unnecessary for periodic cleaning.

Materials: Cleaning rod, cotton flannel patches (cut to fit snugly into the bore), a small tooth-brush, good quality light gun oil, *gun cleaning solution, and *a brass wire bristle bore cleaning brush.

NOTE: In freezing conditions (below 32°F or 0°C) avoid the use of oil for lubrication; instead, apply a dry lubricant sparingly.

Procedure:

1. **CAUTION: ENSURE THAT THE REVOLVER IS NOT LOADED.**
2. Open the cylinder as previously described (See Figure 2).

Note: Avoid contact between cleaning rod and muzzle as resultant wear will reduce accuracy. Take care to avoid striking rear frame of revolver as severe cases result in burring of the metal around firing pin hole which could contribute to eventual firing failures.

3. Attach cotton flannel patch to end of cleaning rod, insert it in muzzle and pass rod and patch down through barrel. Repeat, changing patches until last patch comes out clean.
4. Clean each of the six chambers in cylinder with similar method to step 3 above.
5. Visually inspect barrel and chambers; if they are clean, proceed directly to step 8, but if they remain dirty, continue with step 6.
6. ***(Note: This item should be needed only after firing.)** Attach brass wire bristle brush to cleaning rod and dip brush in gun cleaning solution. Thoroughly scrub out barrel and cylinder chambers, passing the brush all the way through before reversing the movement. If you try to change direction with brush in barrel or chamber, the brush will stick. Note that painted and plated surfaces could become damaged or streaked when exposed to gun cleaning solution, so follow the manufacturer's instructions.
7. Repeat steps 3, 4 and 5 above.
8. Clean rear face of barrel and revolver frame and front face of cylinder, using a small toothbrush then remove all trace of gun cleaning solution.

9. Lightly moisten a flannel patch with gun oil and pass it once through the barrel, leaving a thin film of oil on the inside surface. Similarly oil the six chambers in cylinder. Leave this film of oil on the metal surfaces if revolver is to be stored. If it is not to be stored, or if it is being removed from storage for use, pass a dry patch through barrel and chambers to remove as much oil as possible. (See note on cold weather lubrication.)
10. Check that flannel or brush bristles have not become lodged in any part of revolver, then wipe all external surfaces including those between hammer and frame with a flannel patch lightly moistened with gun oil.
11. Remove any gun cleaning solution and oil from grip.

STORAGE

CAUTION: ALWAYS UNLOAD YOUR REVOLVER FOR STORAGE AND STORE AMMUNITION SEPARATELY. Keep and store your revolver and ammunition securely locked and in separate locations out of reach and sight of children and untrained people. (Children are naturally curious and do not always believe the real danger of guns.)

Note: Do not store your revolver in an air-tight container, and do not seal or attempt to seal the barrel or chambers to exclude dust, as the internal steel surfaces are more likely to corrode. Use the Colt packaging case to carry and store your EMPTY revolver.

SERVICING AND REPAIR

Should your revolver require adjustment or repair, make sure it is NOT LOADED and take it, or send it to the nearest COLT AUTHORIZED REPAIR SERVICE STATION (a list of addresses is provided separately). For spare parts, seek advice from the Dealer who should have up to date information on how best to obtain genuine Colt parts.

An illustration and list of part names are included in the next section of this instruction manual to help you identify the part you need, but it is important to note that all parts are not available for sale. Those parts which are available should be installed at a Colt Authorized Repair Service Station. When ordering parts, please give part name as given on the Parts List. Also give the caliber, model name, serial number and metal finish of your revolver, i.e., whether blue or nickel.

IMPORTANT: If you make unauthorized adjustments or use unauthorized parts, Colt will not assume responsibility for the functioning of this revolver.

THIS GUN IS MANUFACTURED TO PERFORM PROPERLY WITH THE ORIGINAL PARTS AS DESIGNED. IT IS YOUR DUTY TO MAKE SURE ANY PARTS YOU BUY ARE INSTALLED CORRECTLY AND THAT NEITHER REPLACEMENTS NOR ORIGINALS ARE ALTERED OR CHANGED. This is why we say take it to a Colt Authorized Repair Service Station. YOUR GUN IS A COMPLEX TOOL WITH MANY PARTS THAT MUST RELATE CORRECTLY TO OTHER PARTS. PUTTING A GUN TOGETHER WRONG OR WITH MODIFIED PARTS CAN RESULT IN A DAMAGED GUN, DANGER, AND INJURY OR DEATH TO YOU AND OTHERS THROUGH MALFUNCTION. ALWAYS LET A QUALIFIED GUNSMITH WORK ON YOUR GUN AND CHECK ANY WORK YOU THINK WAS NOT PERFORMED BY A GUNSMITH. We at Colt think this is a small price to pay for firearms safety.

Note: Various Federal and State laws and local ordinances govern the transfer and transportation of firearms, so take the advice of the Dealer in your state on how to send or transport your firearm to a Colt Authorized Repair Service Station. Before shipping your revolver, here are some important points to remember:

- 1. CAUTION: MAKE SURE THE REVOLVER IS NOT LOADED.**
2. Write a letter explaining the problem and your requirements in as much detail as possible. Include the model name and serial number of your revolver together with your return address, then enclose it with the revolver in a well padded package.
3. Do not send presentation boxes, accessories, or ammunition.
4. A list of Colt Authorized Repair Service Stations is provided with your revolver.
5. Do not indicate the contents, or include "COLT" in the address on the pack so that an inquisitive thief is not attracted to it by such information.
6. Insure the package and its contents against loss or theft.

SECTION 6**PARTS ILLUSTRATION AND LIST**

This section is provided so that you may identify names of parts for your own interest. However, for adjustment, repair or spare parts information, see Section 5 "Servicing and Repair."

See page 40 for illustration.

See page 41 for description of parts.

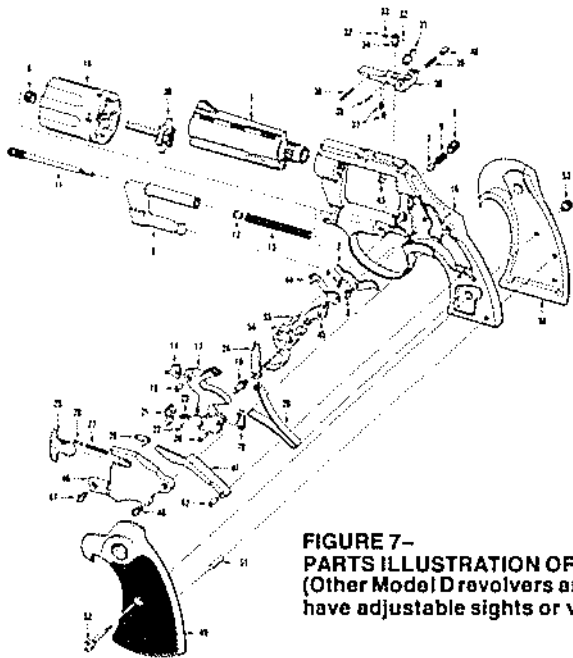

FIGURE 7-
PARTS ILLUSTRATION OF DIAMONDBACK
(Other Model D revolvers are similar, but do not
have adjustable sights or ventllated barrel rib.)

DESCRIPTION

- | | | |
|-------------------------|----------------------------------|-------------------------------|
| 1. Barrel | 20. Hammer Stirrup Pin | 38. Rear Sight Leaf Pin |
| 2. Bolt | 21. Hammer Strut | 39. Rear Sight Windage Spring |
| 3. Bolt Screw | 22. Hammer Strut Pin | 40. Rear Sight Windage Screw |
| 4. Bolt Spring | 23. Hammer Strut Spring | 41. Rebound Lever |
| 5. Crane | 24. Hand Assembly | 42. Rebound Lever Pin |
| 6. Crane Bushing | 25. Latch | 43. Recoil Plate |
| 7. Crane Lock Detent | 26. Latch Pin Assembly | 44. Safety Assembly |
| 8. Crane Lock Screw | 27. Latch Spring | 45. Safety Lever |
| 9. Crane Lock Spring | 28. Latch Spring Guide | 46. Side Plate |
| 10. Cylinder | 29. Main Spring | 47. Side Plate Screw |
| 11. Ejector Rod | 30. Ratchet and Stem | 48. Side Plate Screw |
| 12. Ejector Rod Bushing | 31. Rear Sight Blade | 49. Stock LH |
| 13. Ejector Spring | 32. Rear Sight Det. Ball | 50. Stock RH |
| 14. Firing Pin | 33. Rear Sight Det. Spring | 51. Stock Pin |
| 15. Firing Pin Rivet | 34. Rear Sight Elev. Screw | 52. Stock Screw |
| 16. Frame | 35. Rear Sight Elev. Screw Pin | 53. Stock Screw Nut |
| 17. Hammer | 36. Rear Sight Leaf | 54. Trigger Assembly |
| 18. Hammer Pin | 37. Rear Sight Leaf Elev. Spring | 55. Trigger Pin |

Our Colt Custom Shop offers a wide range of special services such as engraving, inlaying and special serializing to the same high standard of quality long synonymous with the name "COLT." Sometimes modifications, which meet our customer's special requirements, necessitate deviations from standard design and manufacturing tolerances which result in functional differences from a standard gun. Consequently, this instruction manual does not apply to a customized gun unless its applicability has been confirmed by the Colt Custom Shop. For further information, write to Colt's Manufacturing Company, Inc., Custom Gun Shop, P.O. Box 1868, Hartford, Connecticut 06144-1868, USA.

FIREARM RECORD

Colt Model _____

Serial No. _____

Caliber _____

Purchased
from _____

Date
Purchased _____

Purchase
Price _____

WARRANTY STATEMENT

Based on Magnuson-Moss Warranty Act, Colt offers no express warranty on its product line. However, Colt recognizes its obligations concerning implied warranty. Colt also stands behind its products as it has historically, and will continue to provide services to its product line as it has over the years. Colt products will be serviced for a period of one year from the date of retail purchase, for defects in materials or workmanship, at no charge to the purchaser. Be sure to retain your sales slip as proof of purchase date when making a claim.

If your instruction manual becomes lost or destroyed, obtain a replacement by writing to **Colt's Manufacturing Company, Inc., Box 1868, Hartford, Connecticut 06144-1868, USA** or call **1-800-962-COLT**. Make a note of the address. When requesting a manual, include the information which is on the left side of your firearm together with its serial number or quote the Part No. as shown on the back cover of this manual.



, the Rampant Colt figure, Agent[®], Cobra[®], Detective Special[®], Diamondback[®], Police Positive[®], and all other Colt trademarks are the exclusive property of Colt's Manufacturing Company, Inc. For permission to reprint for noncommercial instructional purposes, prior approval from Colt's is required.

This instruction manual should always accompany this firearm. When you lend, give or sell this firearm, be sure this manual goes with it.



Avvertimento Italiano

Se c'è qualcosa che non riuscite a capire, rivolgetevi a qualcuno che sia qualificato nel maneggiare in maniera sicura le armi da fuoco.

Advertencia en Español

Para cualquier aclaración de esta manual, consulte con alguna persona perita en el manejo seguro de armas de fuego.

Message Secutaire en Francais

Pour tous renseignements complémentaires, veuillez consulter un Armurier qualifié dans le maniement de ces armes.

Deutsche Sicherheitshinweise

Sollten Sie noch weitere Fragen haben, wenden Sie sich bitte an einen Waffenspezialisten.

FUNDAMENTAL NRA RULES FOR SAFE GUN HANDLING

1. ALWAYS KEEP THE GUN POINTED IN A SAFE DIRECTION.
2. ALWAYS KEEP YOUR FINGER OFF THE TRIGGER UNTIL READY TO SHOOT.
3. ALWAYS KEEP THE GUN UNLOADED UNTIL READY TO USE.