

WALTHER

P-38

9MM Auto Pistol

**OWNER'S
MANUAL**



CARL WALTHER • WORKS FOR SPORTS-AND HUNTING WEAPONS. ULM DONAU . GERMANY



The **WALTHER** Police Pistol Models PP and PPK have, by virtue of their unique construction, proved themselves to be the World's safest and most dependable handguns.

The absolute faith in these two products induced specialists both at home and abroad to demand a pistol of a similarly recognized and approved construction which would retain **the** principle of a **very** light **weight** and at **the same time fire the more** powerful **cartridge** Cal. 9 mm **Parabellum**.

The outcome of the appropriate considerations was **the** new **WALTHER** Model P **38** Cal. 9 mm **Parabellum**, which combines a phantastically low **weight** of only a **little** over **27** ounces with all **the desirable** advantages of a modern handgun – absolute safety, instantaneous readiness, and easy handling – and which allows the **use** of a considerably more potent cartridge. This pistol stands without rival.

All **the** component parts are **interchangeable**. They are **made** by means of **the** most **up-to-date** production methods involving the use of modern machinery under strictest **super-**vision. As in the **manufacture** of any other of the **several WALTHER** products, only **the** very best materials are used in the production of **the** Model P **38**.

The pages of this little brochure will give **a** most detailed and therefore very useful description of the various **data** relating to the pistol Model P 38.



Auto Pistol Model P 38 Cal. 9 mm Parabellum

General Data:

Overall Length . . . 214 mm = 8⁷/₁₆"
 Length of Barrel 125 mm = 4¹⁵/₁₆"
 Height of Pistol . . 136 mm = 5³/₈"

Total Weight . . . 780 g = 27¹/₂ ozs

Magazine capacity . . . 8 Cartridges

Standard Finish . . set block (matted).

The pistol can be supplied, upon request, in a polished and blued finish.

A spare magazine, a cleaning rod, and a test card are supplied with every pistol. The complete equipment also includes a technical description and is delivered in a stout carton.

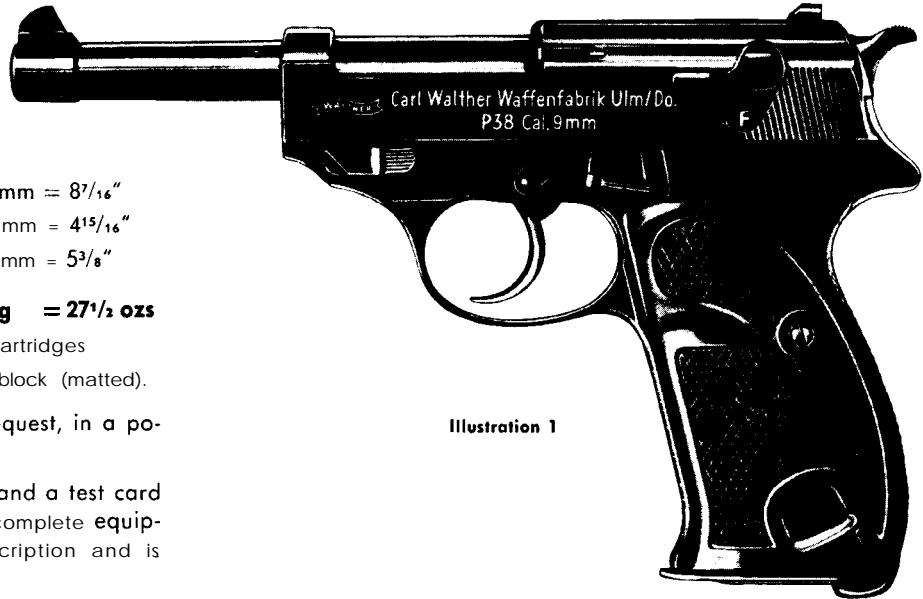

Illustration 1

The pistol P 38 has an external hammer. The combination of a perfect action design, made evident in the **WALTHER** self-loading pistols having an external hammer, and the constant readiness of a revolver makes the enormous advantages of these weapons abundantly manifest.

The P 38 is a double-action, locked-breech, semi-automatic pistol. It is fitted with an external hammer which is connected to a tension trigger and which has a distinctive pressure point. The P 38, like the models PP and PPK, may be fired by merely pulling the trigger. It may, moreover, readily be carried loaded and uncocked.

Cartridges with faulty primer caps can be fired by pulling the trigger repeatedly.

A bulge in the barrel — caused by some irregular agency — will not impede the functioning of the P 38, since the barrel is mounted in an open and unencumbered manner. The pistol is thus always ready for instant use.

An entirely new method has been adopted in the construction of the safety device of the P 38.

As may be well known, there is always a certain amount of danger inherent in any loaded and cocked firearm, even though the latter may be rendered 'safe' by means of the safety lever. Any sudden mechanical **shock** or a fracture of an **action** component can cause an accidental discharge.

In the P 38, this basic evil has been remedied: the rotary safety **catch** does not make the action mechanism safe in the cocked stage. **Instead**, – application of the safety catch causes the hammer to become uncocked, – and that without any danger to the user. When the safety catch is moved to the 'Safe' position, the firing pin becomes **locked** first. Immediately following this, the action mechanism is automatically **blocked** and the hammer drops harmlessly – and the pistol is completely uncocked.

Un-cocking of the hammer by means of applying the **safety** catch, preceded by the locking of the firing pin and the connection with the tension trigger, make the P **38** a truly ideal service pistol.

Since the pistol is thus always uncocked but nevertheless always ready for immediate use, the hammer spring is therefore not subject to fatigue and weakening.

The P **38** can be dismantled within a few seconds and without using any tools. Component parts **cannot** drop out. Any unnecessary operating of the trigger mechanism should be duly avoided, and the hammer should not be allowed to drop while the **chamber** is empty. In any instance of 'dry' shooting practice, a dummy cartridge should be introduced into the chamber first.

It is an essential rule for every shooter that despite the fully guaranteed safety of the weapon, the pistol should always be held so that the muzzle points downwards while the **weapon** is not being actually used.



P 38 Auto Pistol

Cal. 9mm Parabellum

in longitudinal section

In this illustration, the signal pin immediately above the hammer is clearly visible. It indicates that there is a cartridge in the chamber. i. e., that the weapon is loaded. The signal pin remains visible when the safety catch is applied. The pistol is uncocked, but is nevertheless ready for action. Illustration 4 shows how the pistol is fired by merely pulling the trigger (in 'Double-action' shooting).

A list of the individual component parts may be found on pages 17 and 18 of this **technical** description.

Graphic Description

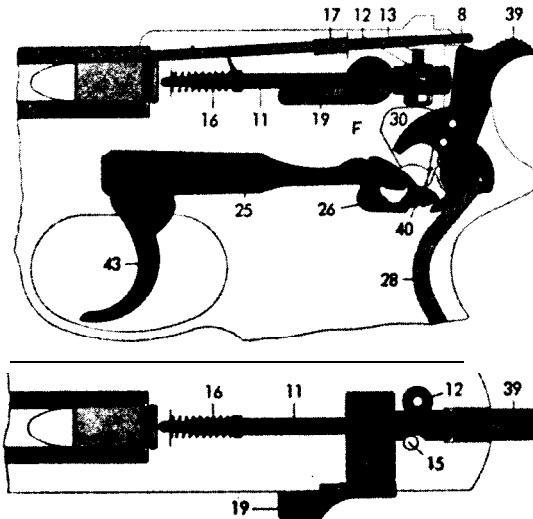

Illustration 3

The pistol is loaded and **uncocked**. The safety lever is 'off'. The pistol is thus ready for instant use ('Double-Action'). Automatic Safety

The pistol, though uncocked and loaded, may thus be fired. The safety lever (19) is in the 'Fire' position. The weapon is, as shown in Illustration 3, entirely free from tension.

The firing pin (11) is **blocked** by the firing pin arrester (12). The live round in the chamber cannot be discharged if the pistol should accidentally be dropped and fall hammer first on the floor. The signal pin (8) can both be felt and seen, and indicates that there is a cartridge in the chamber (Illustration 3).

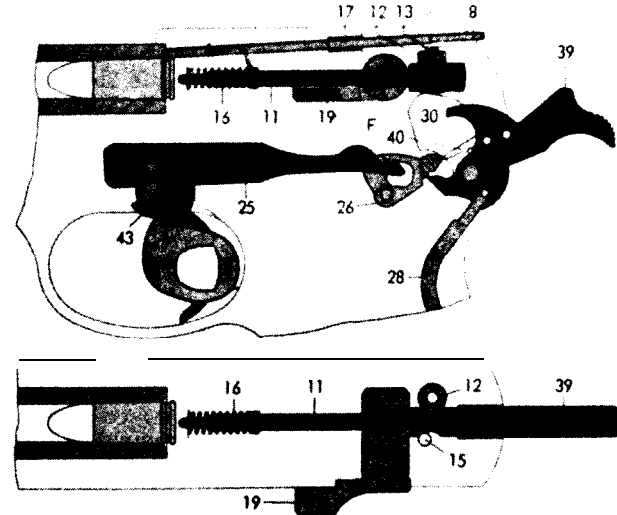

Illustration 4

The pistol is loaded, safety lever 'off', and **cocked** by 'pulling through' (Double-Action trigger motion, shown here in the moment in which the tumbler is about to be released by the sear).

Operating the Trigger

The trigger (43) has been pulled back until the tumbler edge (40) of the hammer (39) barely rests on the sear edge of the tensioning piece (26), as shown in Illustration 4. Until then, the firing pin (11) is blocked by the firing pin arrester (12).

If the trigger (43) is now pulled back a little further, the sear (40) of the hammer slides off the edge of the cocking piece (26), the firing pin arrester (12) releases the firing pin (11), and the hammer (39) strikes the rear end of the firing pin (11).

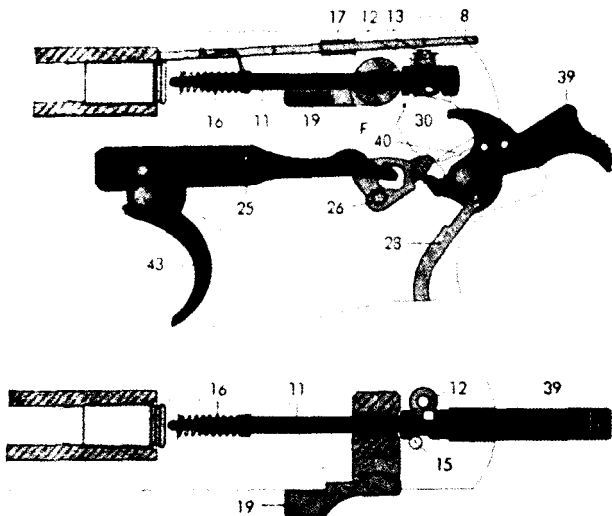

Illustration 5

Pistol loaded and cocked, safety lever 'Off

Operating the trigger when the hammer is **cocked** ('Single-Action').

Upon pulling the trigger (43), the cocked hammer (39) is released from its rearward position by the lifting motion of the cocking piece (26) and strikes the unlocked firing pin (11).

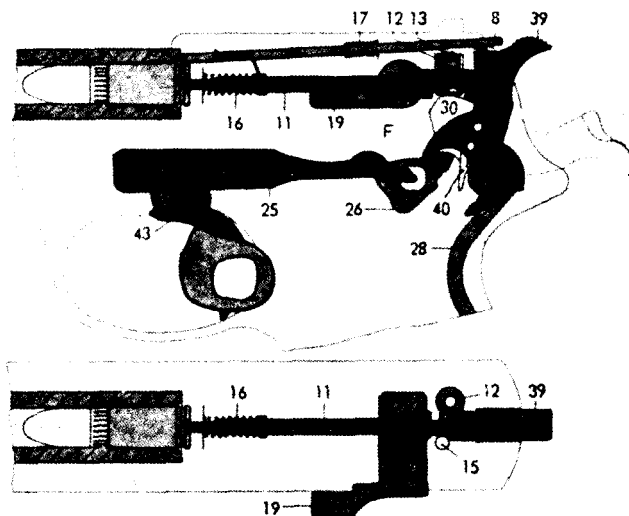

Illustration 6

Pistol at the moment of firing

Process of firing

The hammer (39) strikes the unlocked firing pin (11), and the tip of the latter detonates the primer by hitting and indenting the primer cap, thus igniting the powder charge and thereby causing the resultant pressure gases to drive the bullet out of the cartridge case.

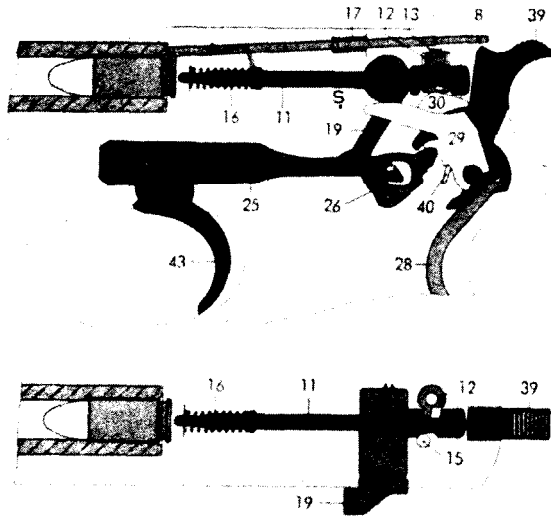

Illustration 7

Pistol loaded, safety lever 'Off

Operating the safety lever when the hammer is cocked. The hammer (39) has been drawn back, and the arm is thus ready. The protruding signal pin (8) indicates that there is a cartridge in the chamber.

If for some reason it is not intended to fire the round, the safety lever (19) should in such case be moved downwards until the letter "S" becomes clearly exposed. This application of the safety lever (19) causes the firing pin (11) to be blocked (see arrows). Moreover, during the last third of the lever travel the hammer (39) becomes disengaged by the lifting of the cocking piece (26) and drops forward. (See also: page 10, - 'Handling' . . ., and Illustration 14.) The trigger moves backwards and remains in the rear-most limit of its travel.

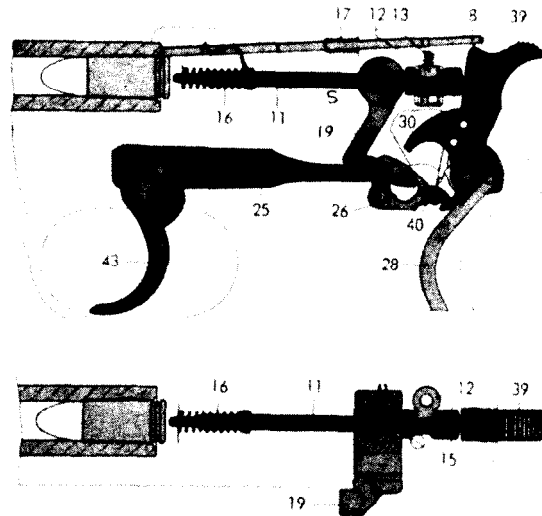

Illustration 8

Pistol loaded, safety lever 'Off

Operating the safety lever when the hammer is uncocked. The firing pin (11) remains blocked by the automatic safety effect of the firing pin arrester (12) when the hammer is in an uncocked state. By moving the safety lever (19) downwards, thereby exposing the letter "S" fully, an additional lock is applied to the firing pin (11), as shown by the arrows in Illustration 8. The trigger remains in its normal position.

Directions for the Use and Handling of the Pistol P 38



Illustration 9

loading

Hold the pistol with the right hand and render it safe by turning the safety lever downwards to the fullest extent of its travel, thus fully exposing the letter "S". Remove the magazine by releasing the magazine catch with the left thumb. The left index finger withdraws the magazine from the grip, as shown in the above Illustration 9.



Illustration 10

Filling the magazine

Hold the magazine with the left hand and push the cartridges – base first – under the magazine lips by carefully depressing the feeder platform with the cartridge rim. The magazine holds 8 cartridges. When emptying the magazine, push the cartridges gently forward until they are finally expelled by the upward thrust of the magazine spring. The 7 holes in the side of the magazine serve to facilitate checking the contents of the magazine.

Any forceful jamming-in or tearing-out during either of these two respective operations would cause damage to the magazine and consequently lead to functional disorders of the pistol.



Illustration 11

Introducing the first cartridge into the chamber

After inserting the full magazine into the pistol grip, hold the pistol with the right hand. The pistol must still be 'safe'. Next, grip the slide by the ribbed rear end with the left hand and pull fully backwards – then let go. This operation causes the first cartridge to slip into the chamber. The hammer, however, does not become cocked by this process, as the safety lever is still applied and the hammer of the P 38 therefore cannot be cocked either by hand or else by pulling the trigger through. To make the pistol ready for immediate use, push the safety lever upwards to cover the letter "S" completely and the letter "F" ('Fire') becomes visible. The weapon will still remain uncocked, since the firing pin is still blocked. The pistol is nevertheless ready for firing.



Illustration 12

'Single-Action' shooting

In target shooting, it is recommended to cock the hammer with the right thumb as shown in Illustration 12. With a little practice, this operation should become fairly easy. It offers the advantage of having only a comparatively slight amount of resistance (trigger pressure) to overcome. This in its turn increases the accuracy in shooting quite considerably.



Illustration 13

'Double-Action' shooting

Firing the first shot by means of the 'single-action' method is, of course, chiefly enacted in practice and competition shooting at targets, while 'double-action' shooting occurs mainly under active service conditions. In the latter event, the hammer is cocked by simply pulling the trigger through its entire length of travel for the first shot.

Should for reasons of faulty ammunition the pistol fail to fire in such exceptional cases, the trigger should be pulled again. A second impact of the firing pin on the primer cap will as a rule cause even a defective round to detonate.



Illustration 14

Operating the safety lever

Hold the weapon with the right hand, and place the right index finger along the side of the trigger guard. The right thumb grips the hammer, while the left thumb pushes the safety lever downwards. The hammer can now slowly return to its resting position, as shown in illustration 14. Care should be taken that the muzzle of the pistol points downwards.



Illustration 15

The emptied magazine

When the last round in the magazine has been fired, the slide stays open. If shooting is to be continued, remove the empty magazine and insert the next full magazine. Pull the slide **back** lightly and then let it glide forwards. This process will cause the first round to be introduced into the chamber.

This cartridge may also be fed into the chamber without using the left hand: by simply depressing the catch lever with the right thumb. If it is not intended to continue shooting, apply the safety lever (see page 10, Illustration 14).



Illustration 16

Unloading

If the pistol P 38 is to be unloaded after a live round has been lodged in the chamber, put the safety lever into the Safe' position (see page 10, Illustration 14), withdraw the magazine, and remove the cartridges from the latter. Now pull the slide fully back (as shown in Illustration 16). The cartridge will be extracted from the chamber by this operation and drop out.



Illustration 17

Dismantling

insert an empty magazine. Hold the pistol with the right hand and move the safety lever to 'Safe' (see page 10, Illustration 14). Next, pull the slide back until it stays open, and remove the magazine. Then turn the barrel catch lever downwards with the left thumb until it engages with an audible 'click'.

If an empty magazine is not available, the retracted slide may be made to stay open by pushing the catch lever upwards.



Illustration 18

Dismantling

The barrel catch lever having been pushed down, the slide should now be pulled **back** slightly and then be allowed to move forward so as to be separated from the **frame**.

Alternatively, the slide may be drawn **back** with the left hand while the right thumb depresses the breech catch lever. Following this, the slide may be allowed to glide forward and off the frame unit.

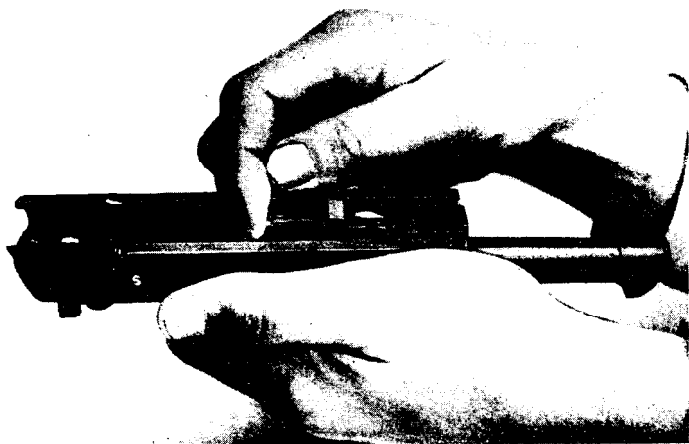

Illustration 19

Separating the barrel from the slide

Hold the slide upside-down in the left hand as shown in illustration 19. Press the small internal locking bolt towards the muzzle end with your right index finger. The barrel can then be readily taken out of the slide unit.



Illustration 20

Cleaning the component parts

The pistol has now been partly stripped and split up into its four main units: barrel, slide, frame (grip), and magazine, as shown in Illustration 20. These components can now be cleaned and oiled.

The barrel, the grooves of the slide, and the grip unit should be lubricated with a good, acid-free, and non-resinous oil, and the barrel should then be wiped dry again.

Any further dismantling should be carried out only if there is an uncommonly great amount of dirt present in these parts. Any such work, however, should be entrusted to skilled craftsmen.



Illustration 21

Assembling

The re-assembling of the **weapon is appropriate** carried out in the opposite order to **that of taking-down**. In order to avoid damage during this process, it is important that the following explanations and illustrations be observed:

It is particularly important to realize that re-assembling can be carried out only while the pistol is in a 'safe' state, i. e., the hammer must be 'down'. First, re-fit the barrel to the slide. When attaching this re-assembled unit to the grip unit, ensure that the **locking** bolt below the chamber is pressed upwards with the left thumb in the manner shown in Illustration 21. The slide unit can now be freely pushed back over the frame top without any fear of damage to the recoil springs, the slide, or the frame.



Illustration 22

The three protruding parts – ejector, release lever, and trip lever' – must be pushed downwards so as to permit the slide to run freely back over the top of the frame (the three components in question are indicated by arrows in Illustration 22).



Illustration 23

Assembling

Insert the empty magazine into the grip, then pull the slide back until the latter engages and stays open. Now push the barrel catch lever **back** into its normal locking position with the left thumb, as shown in Illustration 23.



Illustration 24

Finally, push the breech locking lever downwards with the right thumb and at the same time pull the slide back with the left hand, then let the slide move forward.

The P 38 is now once again in its complete original state, – safe, and ready for further service.

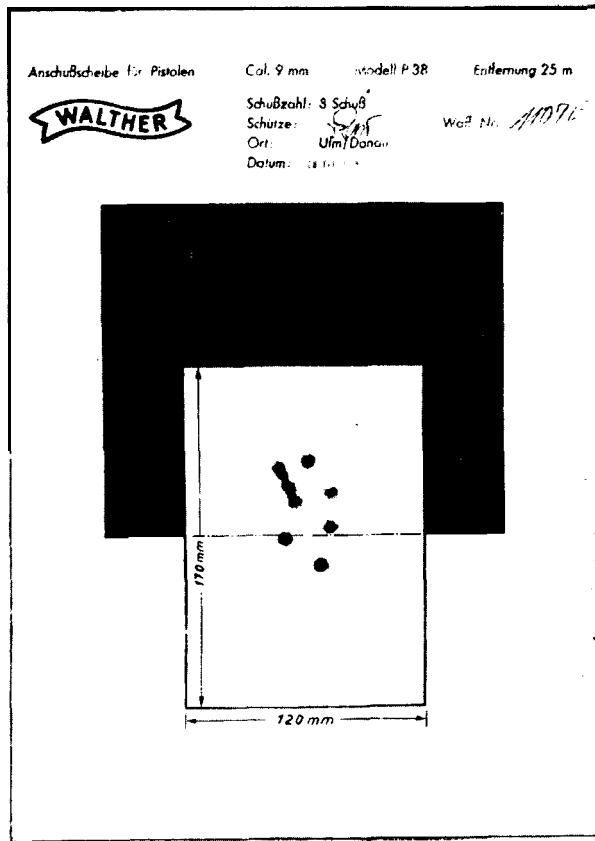

Illustration 25

Test Target with test group of the **WALTHER** Self-loading Pistol P 38, Cal. 9 mm Parabellum.

Ranges and Performance:

Sighting range 50 m = 54.681 yds.

Range of shot, approximately .. 1,600 m = 1,750 yds.

Depth of penetration:

Material	Range		
	25 m 17.34 yds.	50 m 54.68 yds.	200m 18.72 yds.
Loose soil	36 cm 14 ins.	35 cm 13³/₄ ins.	31 cm 12 ins.
Sand	26 cm 10¹/₄ ins.	25 cm 9⁷/₈ ins.	21 cm 8¹/₄ ins.
Pine wood	23 cm 9 ins.	23 cm 9 ins.	17cm 6³/₄ ins.
Sheet iron, 2 mm (0.0787") thick, hit at an angle of 90 degrees	cut clean through	cut clean through	cut clean through

Ammunition

The ammunition for the P 38 is the pistol cartridge
Calibre 9 mm Parabellum.

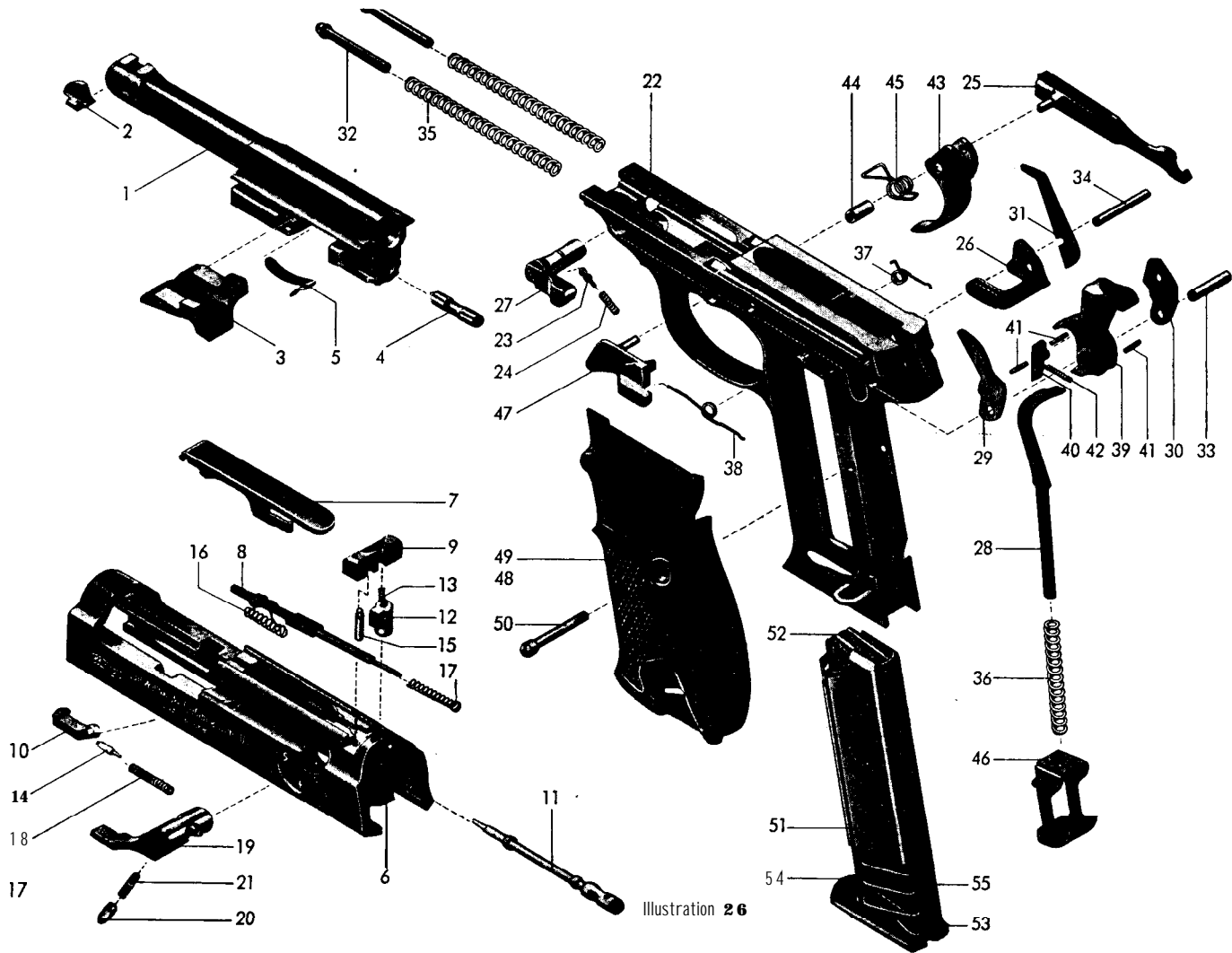

Illustration 26

The Components of the **Walther** Pistol P 38

UNIT I: Barrel		Safety lever unit	19	Cocking piece spring	38
Barrel	1	Rest pin	20	Hammer	39
Front sight	2	Rest pin spring	21	Hammer trap	40
Locking-piece	3			Pins to Nos.39 & 40	41
Locking pin	4	UNIT III: Grip		Hammer trap spring	42
V-spring	5	Frame	22	Trigger	43
		Rest pin	23	Sleeve	44
UNIT II: Slide		Rest pin spring	24	Trigger spring	45
Slide body	6	Trigger connector	25	Magazine holder	46
Cover	7	Cocking-piece	26	Catch lever	47
Signal-pin	8	Barrel catch lever	27	Grip plate, right	48
Rear sight	9	Striker rod	28	Grip plate, left	49
Extractor	10	Relief piece	29	Grip plate screw	50
Firing pin	11	Release lever	30		
Firing pin lock	12	Ejector	31	UNIT IV: Magazine	
Spring to No. 12	13	Recoil spring guide pins	32	Magazine casing	51
Extractor pin	14	Hammer pin	33	Feeder platform	52
Limit stop pin	15	Cocking piece pin	34	Magazine bottom lock	53
Firing pin spring	16	Recoil springs	35	Magazine bottom	54
Signal pin spring	17	Striker rod spring	36	Feeder spring	55
Extractor spring	18	Trigger rod spring	37		

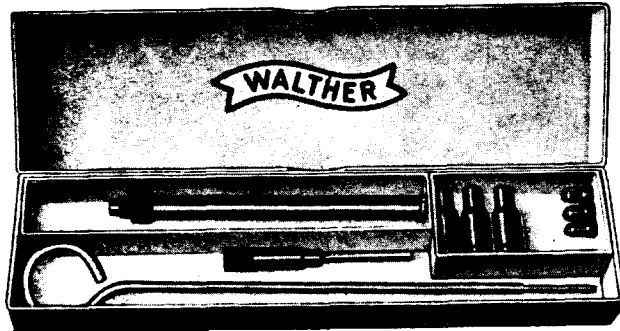

Illustration 27

Conversion Unit Cal. 4 mm (M 20)
for the Pistol P 38
with Steel Adaptor **Cartridges**
comprising:

Insertion barrel (liner) with spring washer and
locking nut

3 steel adaptor **cartridges**

Ejector tool

Cleaning rod

Additional steel adaptor cart-
ridges supplied upon request
and against payment of extra
cost.

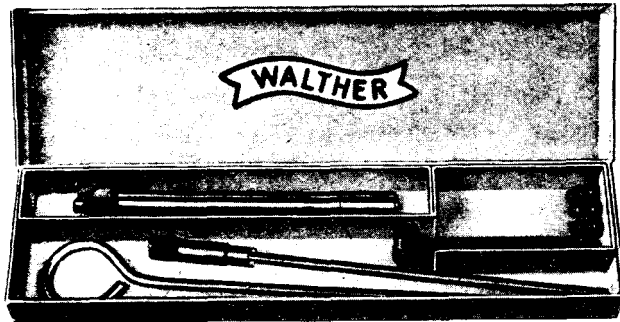

Illustration 28

Conversion Unit Cal. 4 mm (M 20),
with loading tool, for the Pistol P 38
comprising:

Insertion barrel (liner) with spring washer and
lock nut

Loading Tool

Ejector Tool

Cleaning Rod

Instructions for the use of the Conversion Units

(as shown in Illustrations 27 and 28)

Conversion units, developed for the world-renowned **Walther** pistol models PP and PPK and having proved a great success, are now also available for the pistol model P 38. These conversion units make it possible to use the small Cal. 4 mm (M 20) cartridges for all indoor practice shooting.

Fitting

Remove the slide in the usual manner (see page 12). Insert the conversion barrel (liner) into the barrel of the P 38, apply the spring washer and the lock nut, and tighten up with the aid of the ejector tool by applying the latter to the groove.

Shooting practice by using the steel cartridge adaptors

Insert a Cal. 4 mm cartridge into each steel adaptor, then feed the latter into the magazine in the normal manner, and insert the magazine into the grip of the P 38. Next, feed a round into the chamber as demonstrated in illustrations 10 and 11. The pistol is now ready for use. After firing the shot, pull the slide back with the left hand, thereby ejecting the steel adaptor containing the empty case from the chamber. The next 'live' adaptor may now be brought into the chamber by letting the slide move forward, thus closing the breech.

Shooting practice with the aid of the loading tool

Remove the magazine from the P 38, pull the slide fully back, and push the barrel catch lever (breech lock) upwards. The slide will now stay open. Now insert a 4 mm **cartridge** into the chamber by using the loading tool, and release the slide by pulling the latter slightly back. Let the slide move forward and close the breech. The shot may now be fired. After discharging the round, open the breech and push the empty case out of the chamber by means of the ejector tool. The empty case will readily drop out through the magazine shaft.

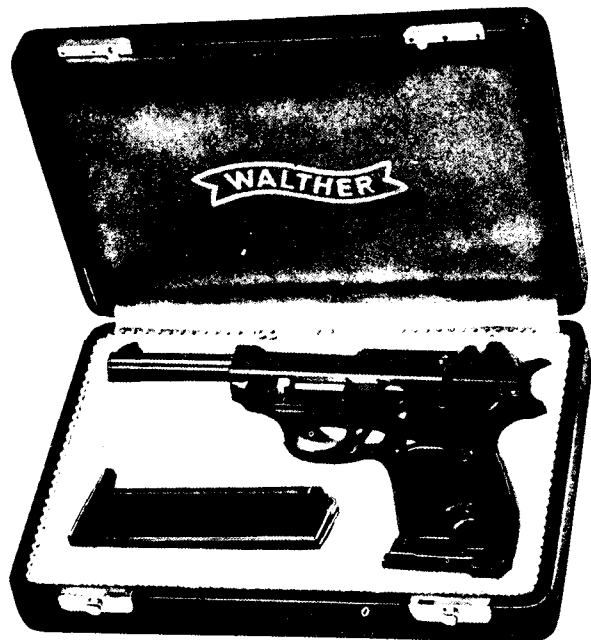
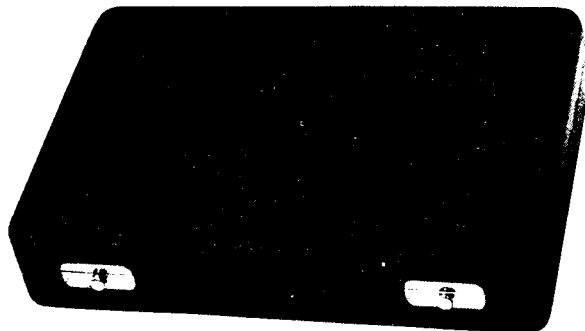

Illustration 29



Upon request, the pistol P 38 can also be made available in a polished and engraved finish, complete with a De Luxe case.

This case, shown in Illustration 29, is made of wood, covered with a good synthetic material, and lined with velvet. It is not lockable.

The case is particularly suitable as a present.

Holster for the Pistol P 38

Cal. 9 mm Parabellum

Made of harness leather, dull black finish outside and smooth inside. External magazine pocket. Two loops for attachment to a belt.

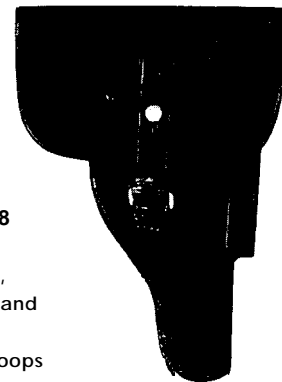

Illustration 30

INDEX

	Page	Illustration		Page	Illustration
General reference:	1	1		Introducing the first cartridge	9 11
Description of pistol	2 & 3	1		'Single Action' shooting	9 12
Sectional view of pistol	4	2		'Double Action' shooting	10 13
Graphic Descriptions:				Rendering the P 38 safe	10 14
Automatic Safety mechanism	5	3		The emptied magazine	11 15
'Double Action' shooting	5	4		Un-loading	11 16
'Single Action' shooting	6	5		Dismantling	12 17 & 18
Process of firing	6	6		Detaching the barrel	13 19
Operating the safety lever:				Cleaning	13 20
a) when the hammer is cocked	7	7		Assembling	14 & 15 21-24
b) when the hammer is not cocked	7	8		Test target and performance	16 25
Directions for the use and handling:				Description of components	17 & 18 26
Loading	8	9		Conversion Units Cal. 4 mm	19 & 20 27 & 28
Filling the magazine	8	10		De Luxe case	21 29
				Holster	21 30



A tradition of over **250** years
of **practical** experience
in the manufacture of precision-built
~~hunting, sports and defence~~ weapons
is intimately associated
with this name.